

Getting Started

AVR-1908

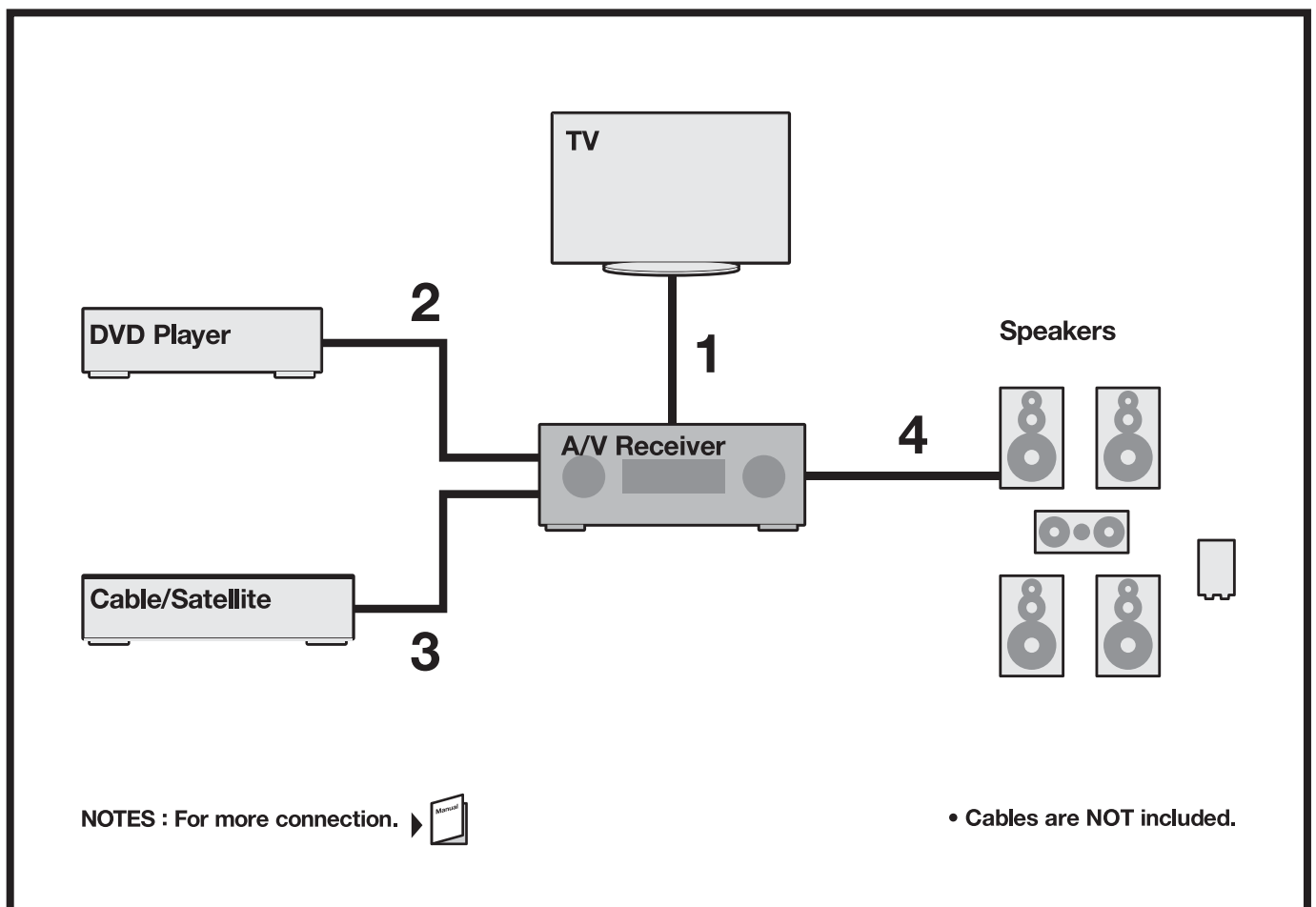

Check & choose your VIDEO connection.

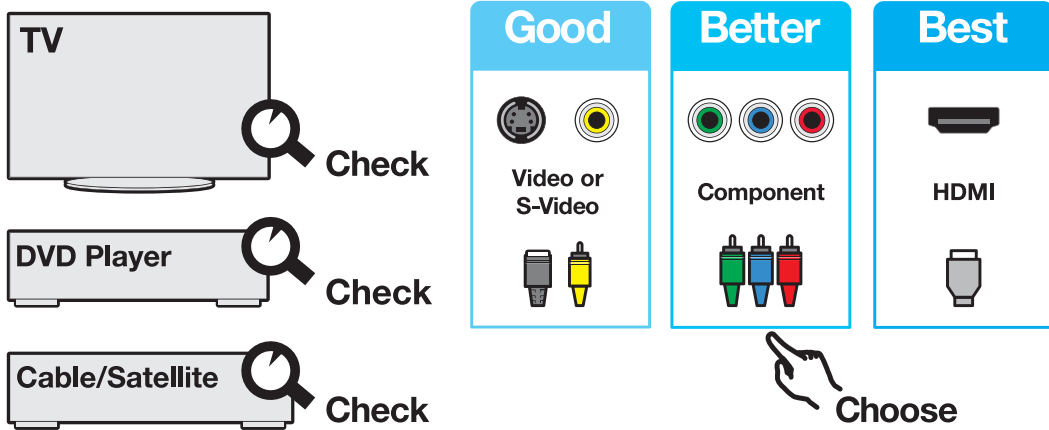

• Follow 2-3 according to your choice of connection. (Read Instruction Manual of your TV set.)

1

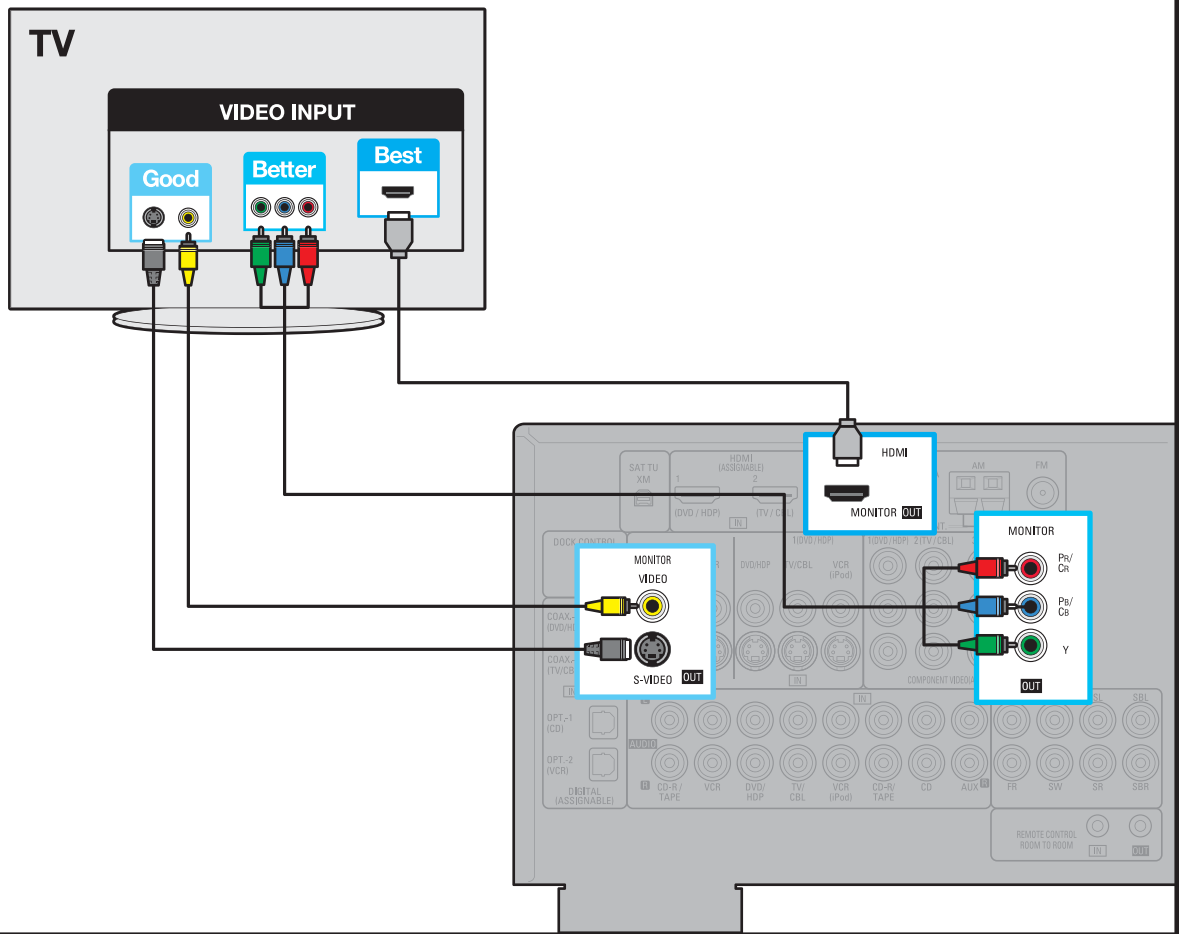

2

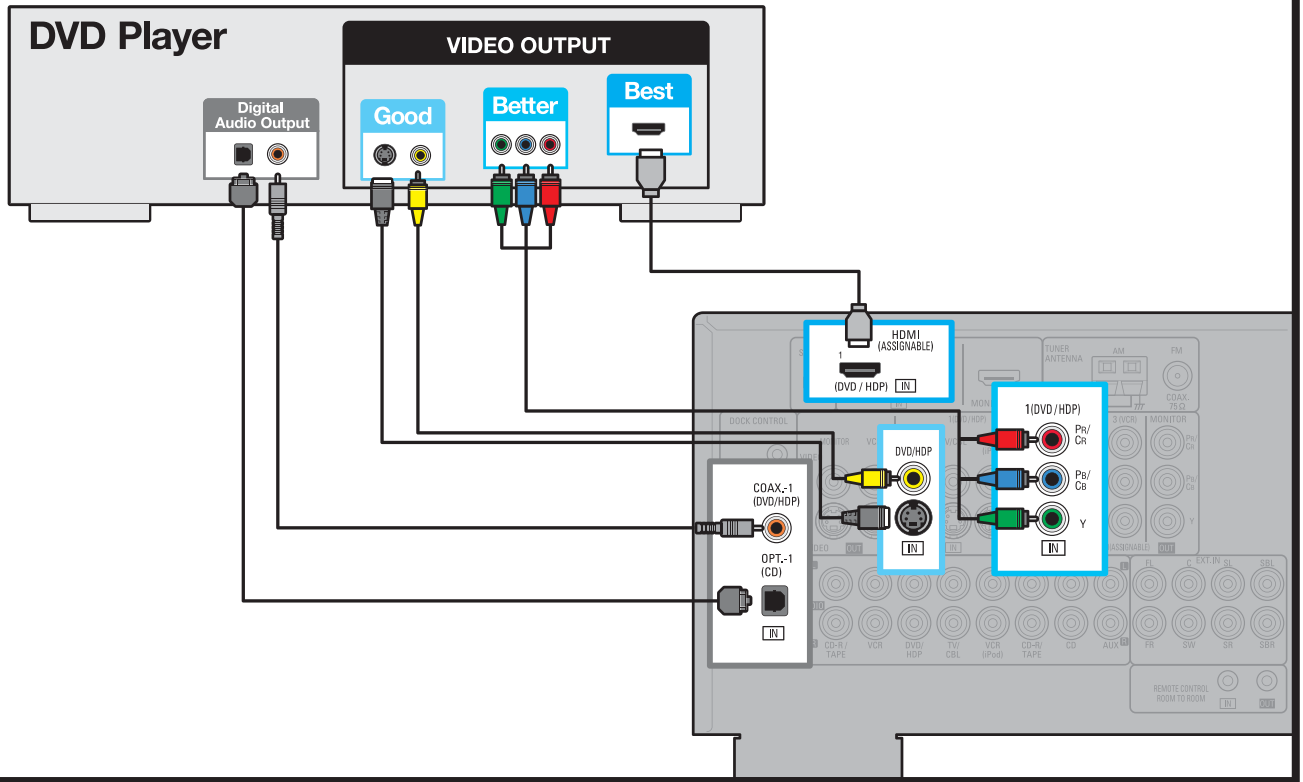

3

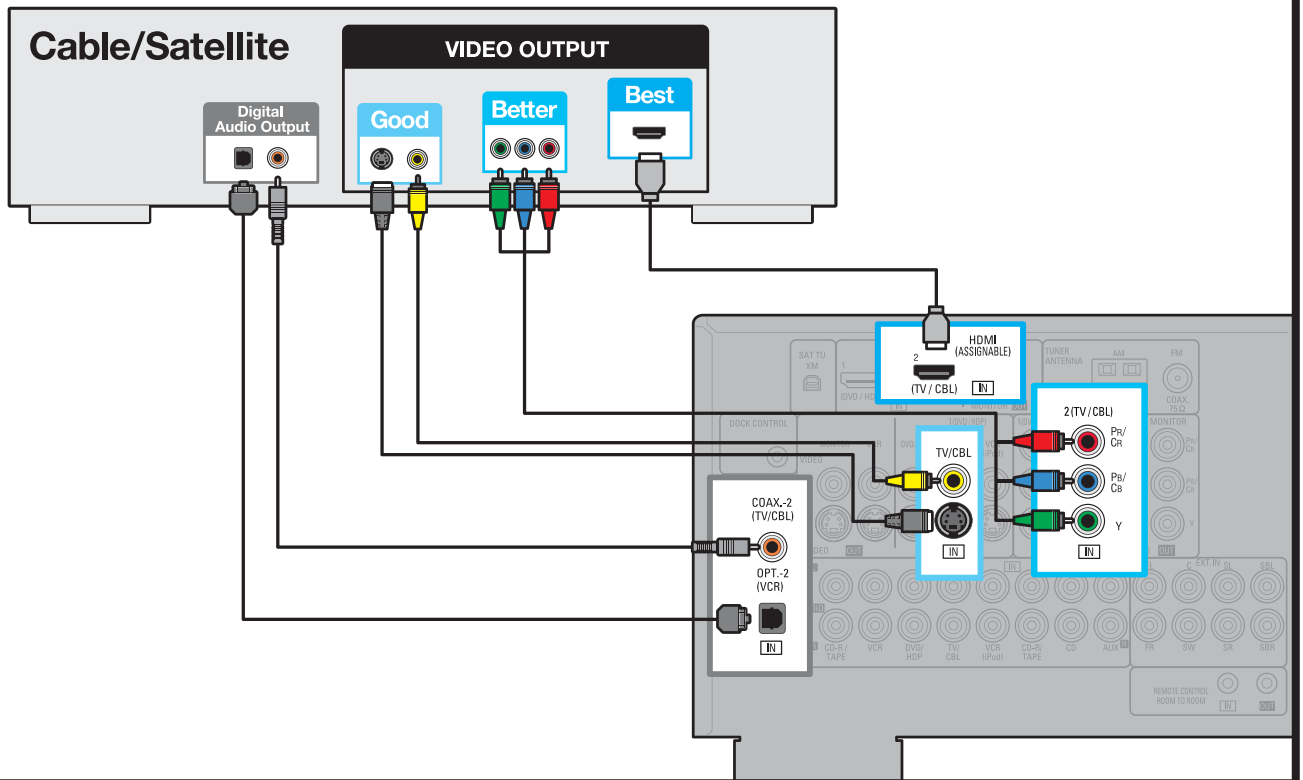

4

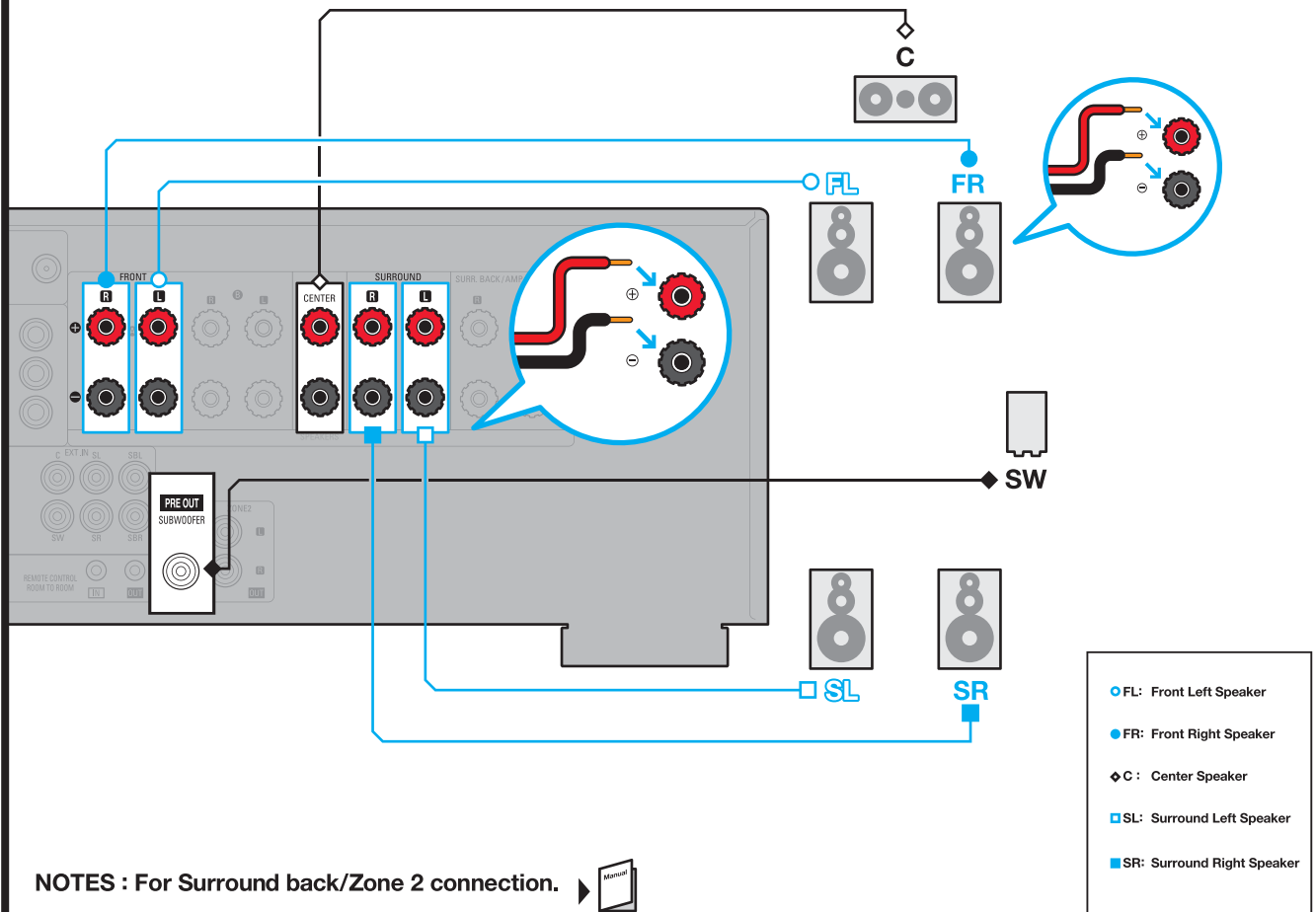
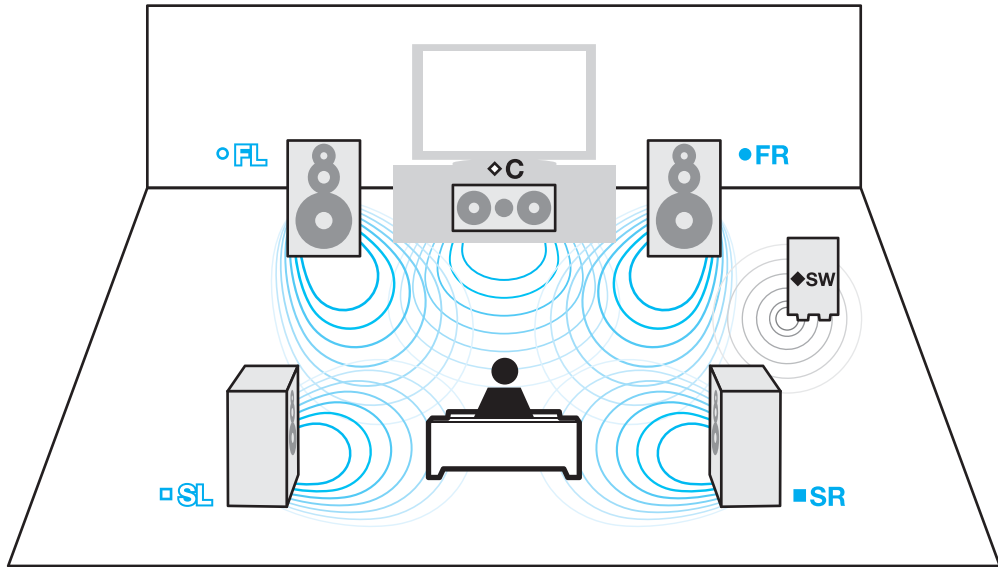

Need more information? 